

T 1 - 2 = 366,0 mm  
 T 2 - 3 = 335,0 mm  
 T 3 - 4 = 349,0 mm

A-A (1:1)

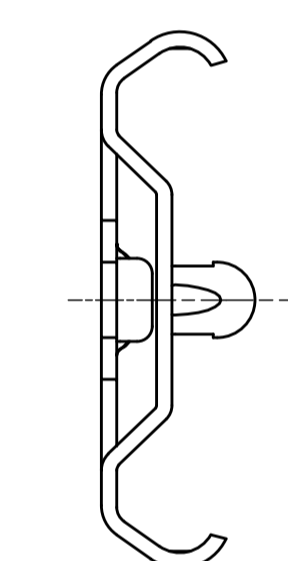

511-11-M36-TA1

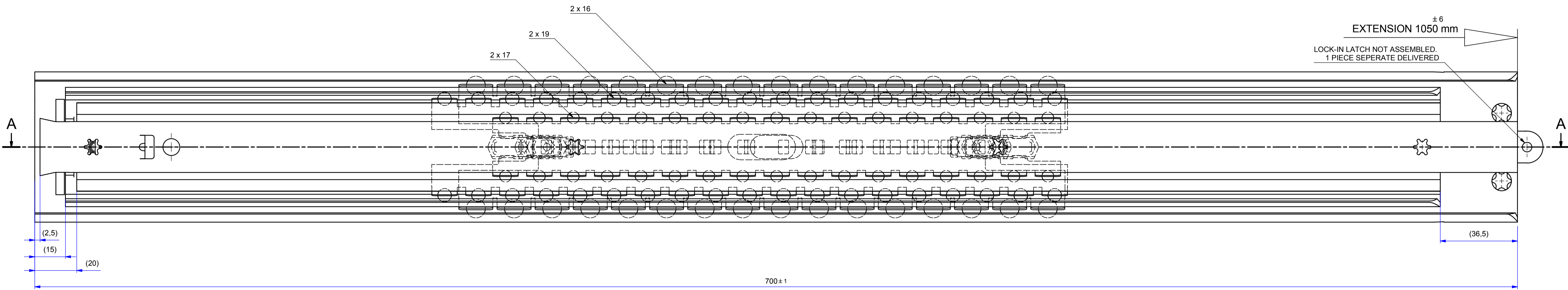
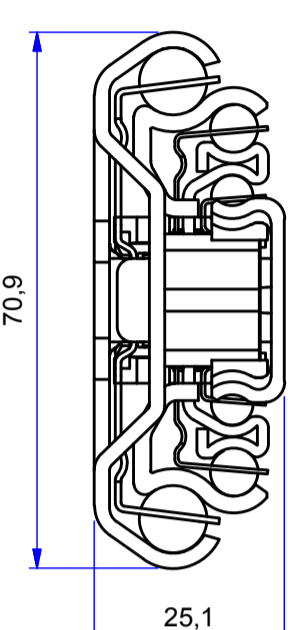
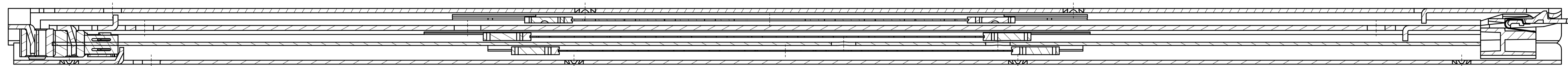
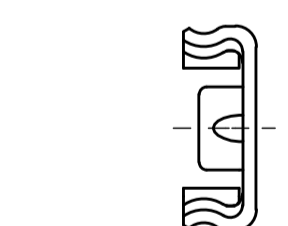
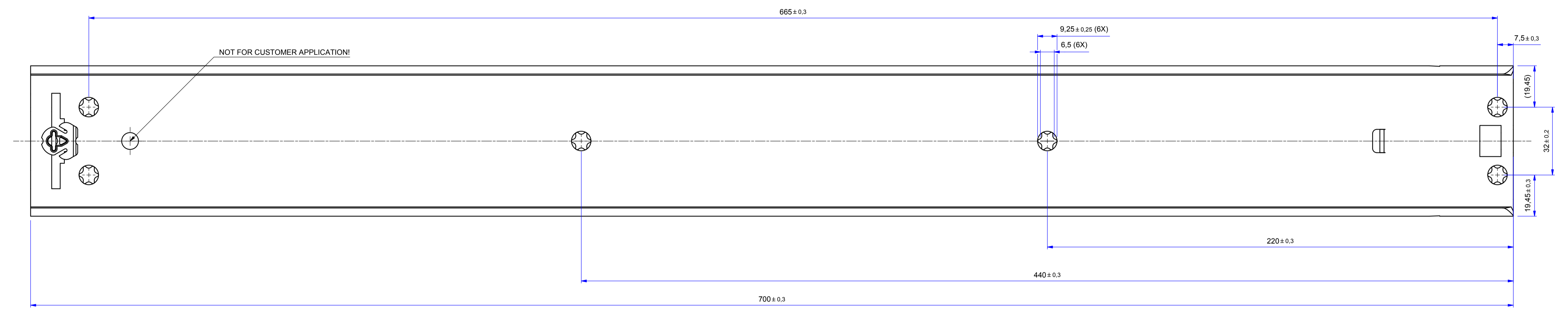

513-11-M36-UB3

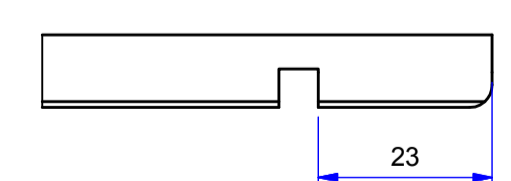
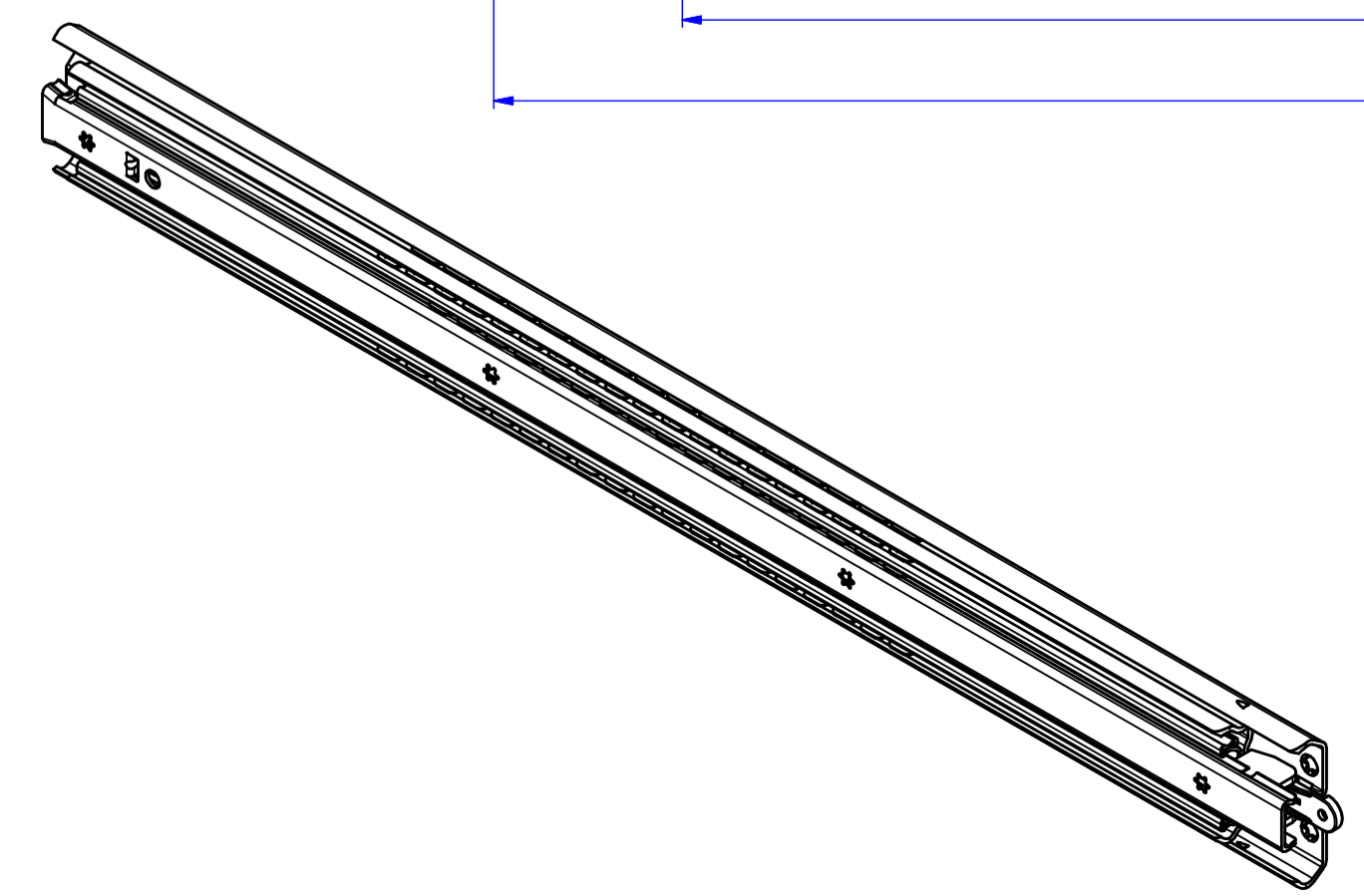
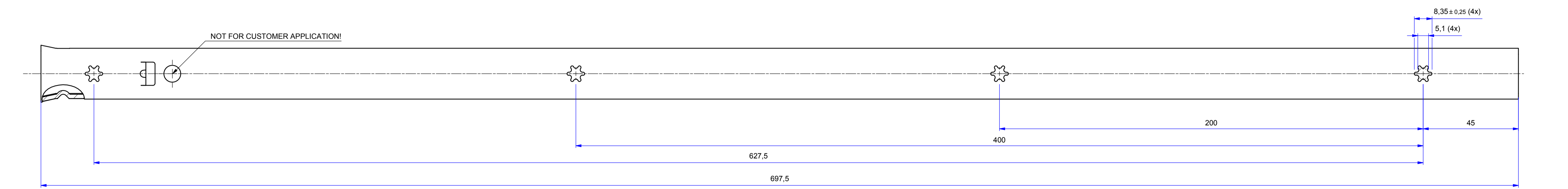

Released for Production

Designer	M. Bulte	Gen.Tol.Dim.	± 0,5	Third angle projection	Material
Date	08-03-2007	Gen.Tol.Angle	± 0,5		Treatment
Approver		Gen.Roughness	Ra		Draw type
Date		Units	mm/deg.	Scale	1 : 1
Description					Model No.
CONDOR 700.0 / 1050.0 (25.1mm)					E000029044
Format	A1	THOMAS REGOUT INTERNATIONAL B.V.		Item No.	111-M36
© THOMAS REGOUT INTERNATIONAL BV, Industrieweg 40, 6219 NR, Maastricht, The Netherlands, +31 (0)43 351 66 66					Revision
					00

Left hand slide = Left hand slide.  
 Dimensions between marks are guide dimensions.  
 Thomas Regout Int. B.V. reserves the right to alter non-customer specific specifications without notice.