

1 2 3 4 5 6 7 8 9 10 11 12 13 14 15 16 17 18 19 20

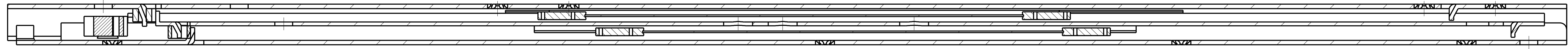

SECTION A-A

T 1-2 = 340.0
T 2-3 = 360.0

EXTENSION 700 ±4 mm

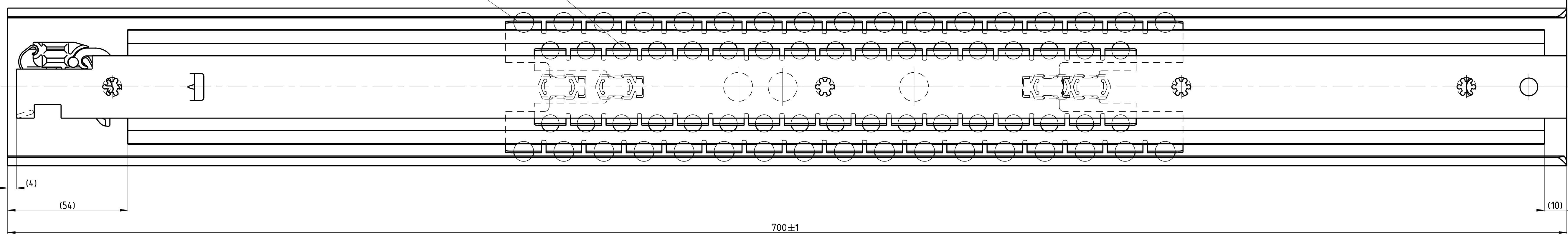
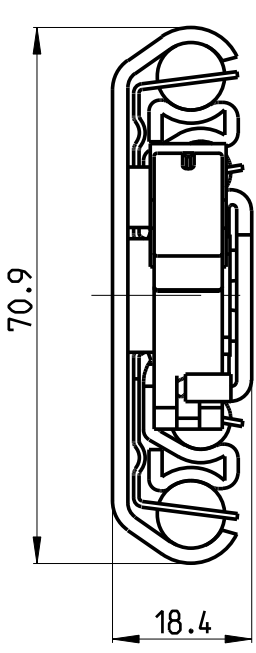

FRONT

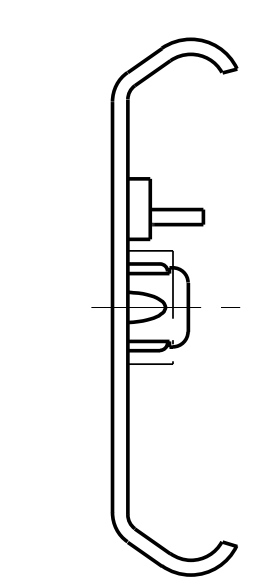

511-01-S68-TA1

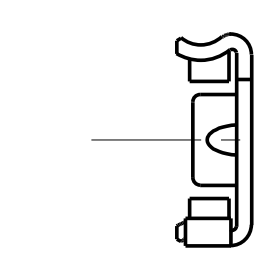
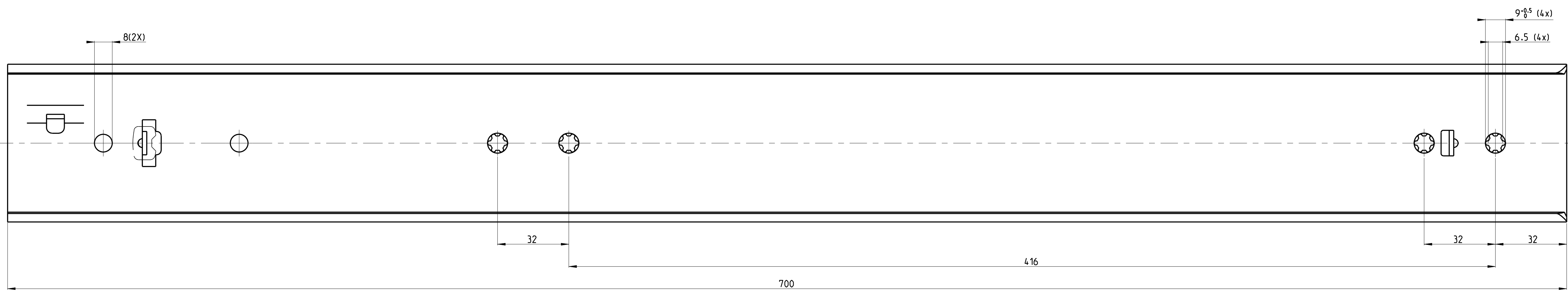

513-01-S68-TA3

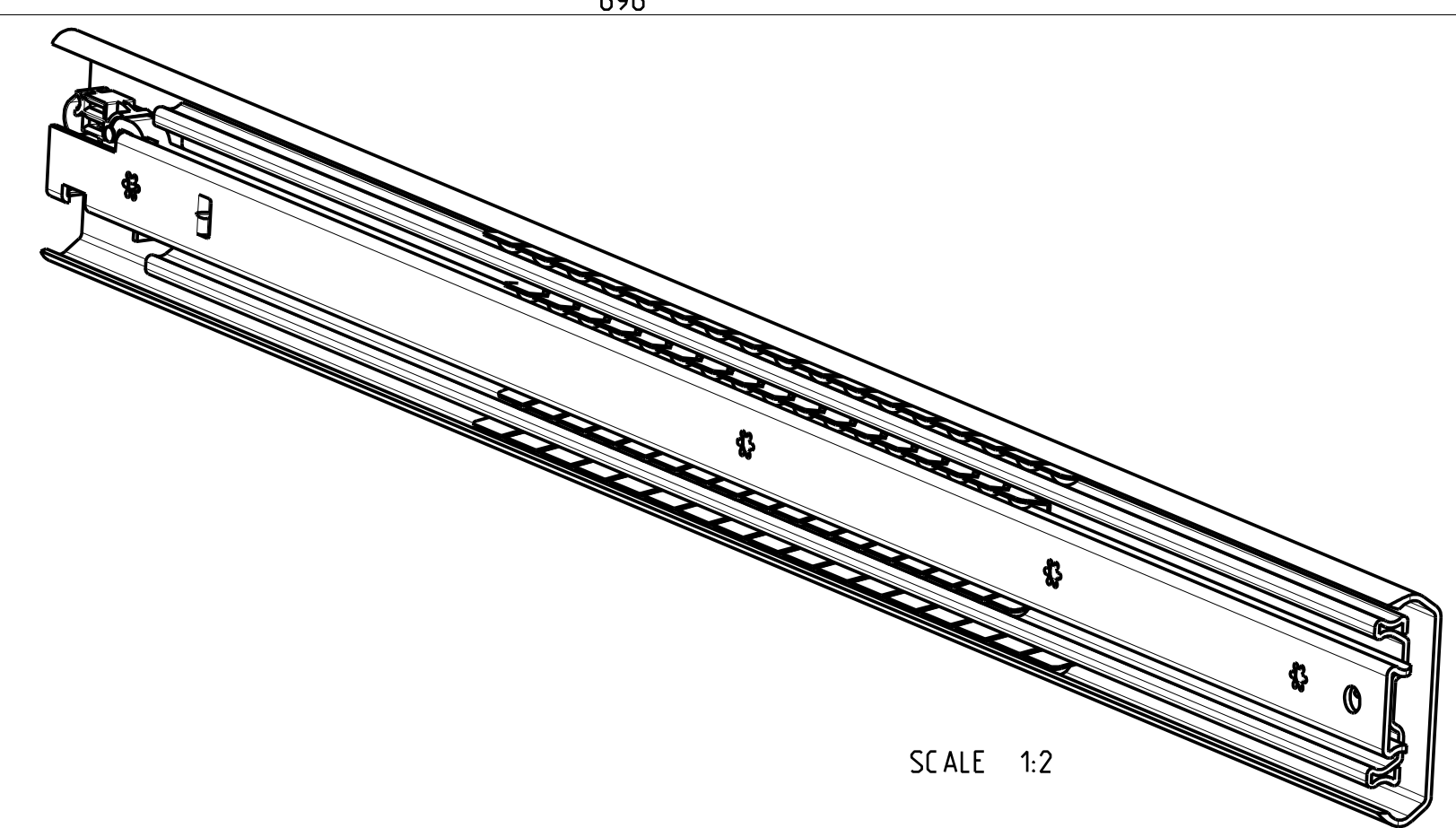
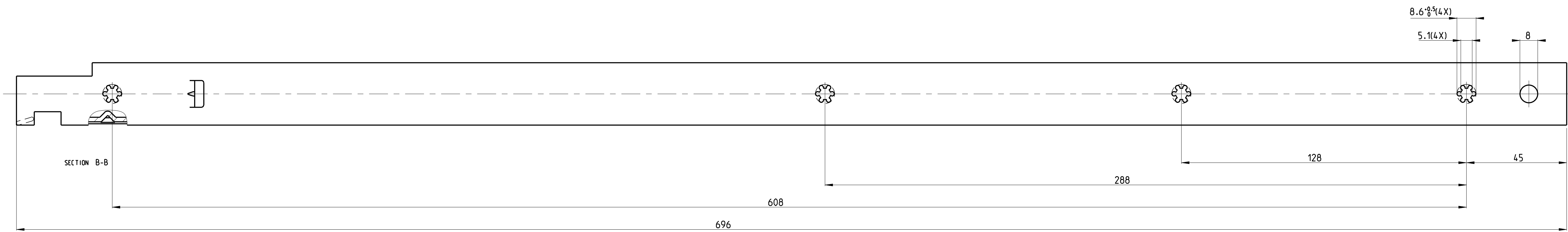

SCALE 1:2

PRO/ENGINEER Drawing		Dimensions between marks are guide dimensions.		Thomas Regout Int. B.V. reserves the right to alter non-customer specific specifications without notice.	
Was: - 101-F98-02		Tolerances unless otherwise stated ±0.5mm.			
American projection	DIMENSION	mm	MAT.:	-	
	SCALE	1:1	REM.:	RIGHT HAND SLIDE = LEFT HAND SLIDE	
	DATE	28-10-2011			
	DESIGNER	M. Mahieu			
	CHECKED	-	Type	F	
TITAN 700.0 / 700.0 (18.5mm)					
THOMAS REGOUT INTERNATIONAL BV			Drw. Nr.		Format.
			101-S68 _ 00		A1
© Thomas Regout International BV All rights are reserved. Production					

04	-	-	05	-	-	-	-	06	-	-	-	-
01	-	-	02	-	-	-	-	03	-	-	-	-