

Changeover Valves

Type 06401 - Bellow Sealed Changeover Valve



Cryogenic Bellow Sealed Changeover Valves, stainless steel, PN63

for the installation of two safety valves,
with indicator and two test connections G 1/4,
"cleaned and degreased for oxygen service"

Part No. 06401.0150.9***

*** In- and outlet connections with locking sleeve, female thread or flanges on request, working pressure up to PN100

Part No. 06401.0250.9***

*** In- and outlet connections with locking sleeve, female thread or flanges on request, working pressure up to PN63

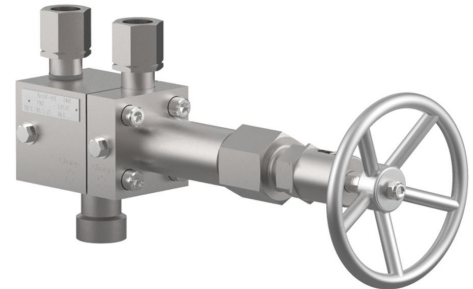

Available options - on request only:

- Changeover valves with pneumatic or electric actuator

Applications:

Approved for air gases, vapours and cryogenic liquefied gases incl. LNG.

Working temperature: -196°C / -321°F (77K) up to +185°C / +365°F (458K)

Materials	DIN EN	ASTM
1 Body I	1.4571	A 276 Grade 316Ti
2 Body II	1.4571	A 276 Grade 316Ti
3 Bellow stem	1.4571	A 276 Grade 316Ti
4 Valve seal	PCTEF	
5 Disc	1.4571	A 276 Grade 316Ti
6 Bellow	1.4571	A 276 Grade 316Ti
7 Head piece I	1.4571	A 276 Grade 316Ti
8 Head piece II	1.4571	A 276 Grade 316Ti
9 Stem	CW452K	B 159 UNS C51900
10 O-Rings	FPM (VITON)	
11 Top ring	1.4571	A 276 Grade 316Ti
12 Handwheel	Aluminium alloy	
13 Welding piece	1.4571	A 276 Grade 316Ti
14 Locking sleeve	1.4571	A 276 Grade 316Ti
15 Thread connection	1.4571	A 276 Grade 316Ti
16 Flange	1.4571	A 276 Grade 316Ti

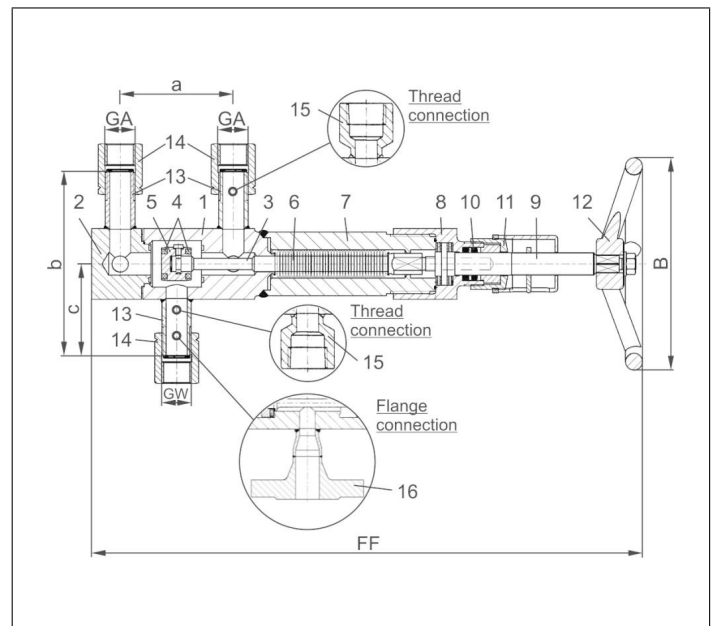

Typ 06401 - Standard design	Technical data		
Nominal size	DN	15	25
Dimension code	.X.	0150	0250
Inlet	GW	G 3/4	G 1
Outlet	GA	G 3/4	G 1
Face-to-face dimension	FF	390	390
Handwheel-Ø	B	150	150
Length	a	80	80
Height	b	130	160
Length	c	65	80
Weight	ca. kg	8.0	9.9
Kvs - Value, one side open	m ³ /h	9.5	13.0
Cv - Value, one side open	gal /min	11.0	15.0
Kvs - Value, central position	m ³ /h	13.5	15.5
Cv - Value, central position	gal /min	15.6	17.9

Dimensions in mm.