

Safety Valves

Type 06850, Type 06855



Safety Valves, angle type, stainless steel, type tested, TÜV-SV.1130. S/G/L

Standard safety valve

metal to metal seated, "cleaned and degreased for oxygen service"

closed bonnet, gastight cap or lifting device

Inlet: male thread type G (BSPP) acc. to ISO 228/1

Outlet: female thread type G (BSPP) acc. to ISO 228/1

Part No. 06850.X.000000M (Pmax 20.0 bar)

Part No. 06850.X.000000H (Pmax 250.0 bar) stellited version

with gastight cap

Part No. 06855.X.000000M (Pmax 20.0 bar)

Part No. 06855.X.000000H (Pmax 250.0 bar) stellited version

with lifting device

Available options - on request only:

· Flange-, NPT- or Tri-Clamp connection for in- and outlet



Applications:

Provided as safety device for protection against excessive pressure in gas cylinders and pressure vessels.

Approved for gases, vapours and liquids. Working temperature: -270°C / -454°F (3K) up to +400°C / +752°F (673K)

Pressure-temperature must be observed, suitable for horizontal installation from 20 bar

Materials	DIN EN	ASME/ASTM
1 Outlet body	1.4408	A 351 CF8M
2 Inlet body	1.4571	A 276 Grade 316Ti
3 Disc	1.4571	A 276 Grade 316Ti
5 Stem	1.4404	A 276 Grade 316L
6 Bonnet	1.4408	A 351 CF8M
7 Spring	1.4571	A 313 Grade 316Ti
8 Cap	1.4408	A 351 CF8M
9 Lifting cap	1.4408	A 351 CF8M
10 Lever	1.4301	A 276 Grade 304
Spare Parts		
2 Inlet body	1.4571	316Ti
3 Disc	1.4571	316Ti
3.1 Split pin	1.4310	301
11 Gasket	1.4404 Graphite	316L Graphite
12 Gasket	PTFE	
13 Gasket	PTFE	
14 O-ring	FPM (VITON)	

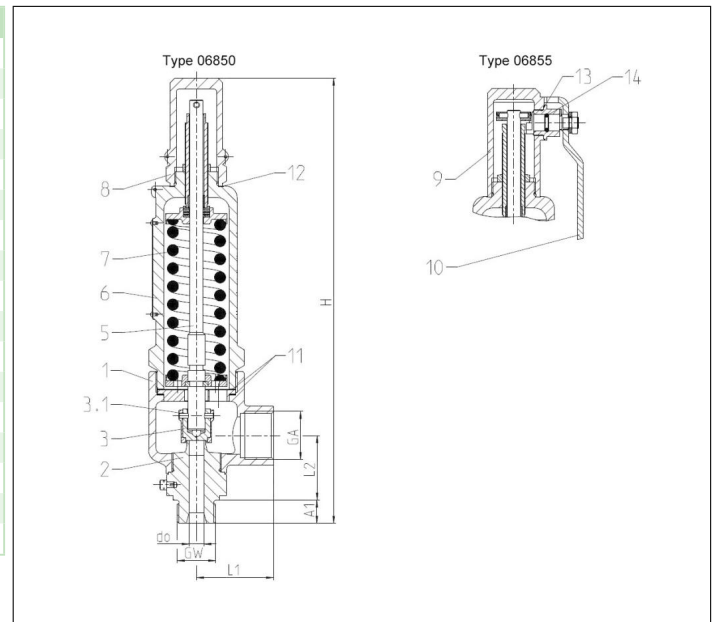

Type 06850, 06855	Technical data	Orifice								
		[mm]	10			14				
Inlet	GW	1/2	3/4	1	3/4	3/4	3/4	1	1	1
Outlet	GW	1	1	1	1	1-1/4	1-1/2	1	1-1/4	1-1/2
Dimension code	.X.	1024	1034	1044	1434	1435	1436	1444	1445	1446
Height	H	305.0	307.0	309.0	310.5	310.5	310.5	312.5	312.5	312.5
Length	L1	53.0	53.0	53.0	55.0	55.0	55.0	55.0	55.0	55.0
Length	L2	44.5	44.5	44.5	48.2	48.2	48.2	48.2	48.2	48.2
Length	A1	14.0	16.0	18.0	16.0	16.0	16.0	18.0	18.0	18.0
Weight 06850	ca. kg	3.2	3.2	3.2	3.4	3.4	3.4	3.4	3.4	3.4
Weight 06855	ca. kg	3.4	3.4	3.4	3.6	3.6	3.6	3.6	3.6	3.6
coefficient of discharge	α_w S/G	0.84	0.84	0.84	0.70	0.70	0.70	0.70	0.70	0.70
coefficient of discharge	α_w L	0.68	0.68	0.68	*	*	*	*	*	*
Min. set pressure	bar-g	0.5	0.5	0.5	0.5	0.5	0.5	0.5	0.5	0.5
Max. set pressure	bar-g	250.0	250.0	250.0	200.0	200.0	200.0	200.0	200.0	200.0
Min. temperature	°C	-270	-270	-270	-270	-270	-270	-270	-270	-270
Max. temperature	°C	+400	+400	+400	+400	+400	+400	+400	+400	+400

Dimensions in mm. * 0.20-11.50 bar=0.50 / 11.51-74.99 bar=0.49 / 75.00-200.00 bar=0.46

Safety Valves

Type 06850, Type 06855



Type 06850, 06855		Technical data					
Orifice	[mm]	18					
Inlet	GW	1	1	1-1/4	1-1/4	1-1/2	1-1/2
Outlet	GW	1-1/2	2	1-1/2	2	1-1/2	2
Dimension code	.X.	1846	1847	1856	1857	1866	1867
Height	H	304.0	304.0	304.0	304.0	306.0	306.0
Length	L1	60.0	63.0	60.0	63.0	60.0	63.0
Length	L2	49.0	53.0	49.0	53.0	49.0	53.0
Length	A1	18.0	18.0	20.0	20.0	22.0	22.0
Weight 06850	ca. kg	3.9	4.1	3.9	4.1	4.0	4.2
Weight 06855	ca. kg	4.1	4.3	4.1	4.3	4.2	4.4
coefficient of discharge	$\alpha_{wS/G}$	0.76	0.76	0.76	0.76	0.76	0.76
coefficient of discharge	α_{wL}	0.50	0.50	0.50	0.50	0.50	0.50
Min. set pressure	bar-g	0.5	0.5	0.5	0.5	0.5	0.5
Max. set pressure	bar-g	110.0	110.0	110.0	110.0	110.0	110.0
Min. temperature	°C	-270	-270	-270	-270	-270	-270
Max. temperature	°C	+400	+400	+400	+400	+400	+400

Dimensions in mm.

Pressure-Temperature Rating

Maximum allowable set pressure safety valve Type 0685X

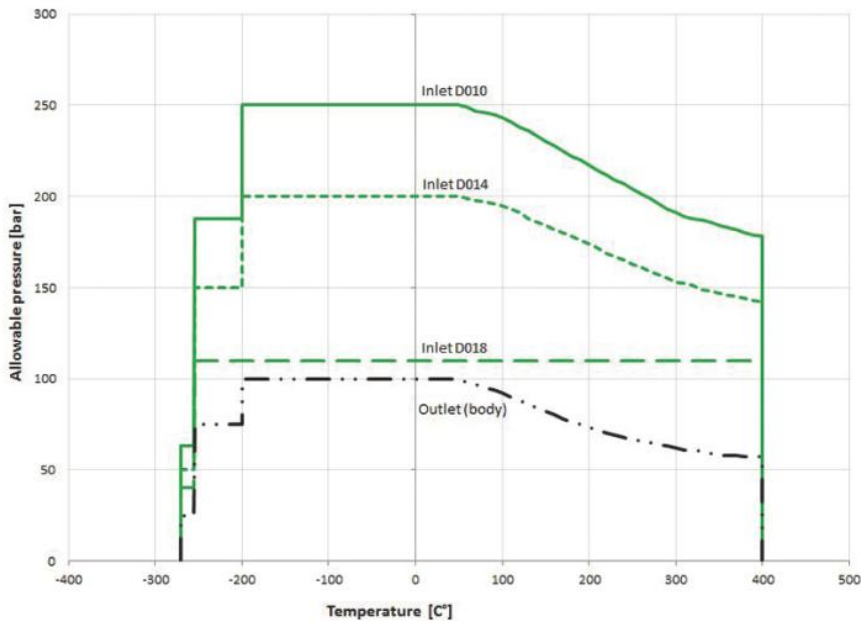

Safety Valves

Type 06850, Type 06855



Discharge capacities

Calculation of flow rate acc. to AD2000-Merkblatt A2 / DIN EN ISO 4126-1

Medium:

A = Saturated steam in kg/h

B = Air in m³/h at 0°C and 1013,25 mbar

C = Water in kg/h at 20°C

The capacity indicated below is for a fully opened valve.

d_0 - orifice

A_0 - flow area

Set pressure in bar (g)	GW	1/2, 3/4 & 1			3/4 & 1			1, 1-1/4 & 1-1/2		
	d_0 (mm)	10.0			14.0			18.0		
	A_0 (mm ²)	78.5			153.9			254.0		
	Medium	A	B	C	A	B	C	A	B	C
0.5		47	56	2075	81	96	3035	127	152	5018
1.0		70	88	2852	116	146	4110	191	242	6794
2.0		112	143	4033	185	236	5813	320	407	9608
3.0		152	194	4940	248	317	7119	444	570	11768
4.0		189	244	5704	309	398	8220	555	715	13588
5.0		227	294	6377	370	480	9190	665	862	15192
6.0		264	344	6986	431	561	10068	774	1007	16642
7.0		301	393	7545	492	642	10874	882	1153	17976
8.0		338	444	8066	552	726	11625	990	1302	19217
9.0		375	494	8556	612	807	12330	1098	1448	20383
10.0		411	545	9018	671	890	12997	1205	1598	21485
15.0		593	794	11045	968	1298	15600	1738	2329	26314
20.0		774	1054	12754	1264	1721	18013	2269	3089	30385
30.0		1140	1572	15620	1861	2568	22062	3341	4609	37213
40.0		1510	2099	18037	2466	3428	25475	4425	6152	42970
50.0		1882	2634	20166	3075	4302	28481	5518	7720	48042
60.0		2256	3175	22091	3685	5186	31200	6614	9308	52628
70.0		2631	3723	23861	4297	6081	33700	7712	10914	56845
80.0		3009	4277	25508	4914	6985	33821	8819	12537	60769
90.0		3394	4835	27055	5543	7898	35872	9949	14174	64456
100.0		3791	5397	28519	6191	8814	37813	11112	15820	67942
110.0		4202	5931	29911	6864	9688	39658	12319	17387	71258
120.0		4629	6513	31241	7561	10637	41422	-	-	-
140.0		5520	7642	33744	9016	12482	44741	-	-	-
160.0		6448	8758	36074	-	14305	47830	-	-	-
180.0		7575	9847	38262	-	16083	50731	-	-	-
200.0		-	10898	40332	-	17801	53475	-	-	-
220.0		-	11931	42300	-	-	-	-	-	-
240.0		-	12983	44181	-	-	-	-	-	-
250.0		-	13522	45092	-	-	-	-	-	-